



Low-Noise, High-Precision, JFET-Input OPERATIONAL AMPLIFIER

FEATURES

- **INPUT VOLTAGE NOISE DENSITY:**
4nV/ $\sqrt{\text{Hz}}$ at 1kHz
- **INPUT VOLTAGE NOISE:**
0.1Hz to 10Hz: 250nV_{PP}
- **INPUT BIAS CURRENT:** 15pA
- **INPUT OFFSET VOLTAGE:** 150 μV (max)
- **INPUT OFFSET DRIFT:** 1.5 $\mu\text{V}/^\circ\text{C}$
- **GAIN BANDWIDTH:** 22MHz
- **SLEW RATE:** 28V/ μs
- **QUIESCENT CURRENT:** 4.8mA/Ch
- **WIDE SUPPLY RANGE:** $\pm 4\text{V}$ to $\pm 18\text{V}$
- **PACKAGES:** SO-8 and MSOP-8⁽¹⁾

⁽¹⁾ MSOP-8 (DGK) package is product preview.

APPLICATIONS

- ADC DRIVERS
- DAC OUTPUT BUFFERS
- TEST EQUIPMENT
- MEDICAL EQUIPMENT
- PLL FILTERS
- SEISMIC APPLICATIONS
- TRANSIMPEDANCE AMPLIFIERS
- INTEGRATORS
- ACTIVE FILTERS

DESCRIPTION

The OPA827 series of JFET operational amplifiers combine outstanding dc precision with excellent ac performance. These amplifiers offer low offset voltage (150 μV , max), very low drift over temperature (1.5 $\mu\text{V}/^\circ\text{C}$, typ), low bias current (15pA, typ), and very low 0.1Hz to 10Hz noise (250nV_{PP}, typ). The device operates over a wide supply voltage range, $\pm 4\text{V}$ to $\pm 18\text{V}$ on a low supply current (4.8mA/Ch, typ).

Excellent ac characteristics, such as a 22MHz gain bandwidth product (GBW), a slew rate of 28V/ μs , and precision dc characteristics make the OPA827 series well-suited for a wide range of applications including 16-bit to 18-bit mixed signal systems, transimpedance (I/V-conversion) amplifiers, filters, precision $\pm 10\text{V}$ front ends, and professional audio applications.

The OPA827 is available in both SO-8 and MSOP-8⁽¹⁾ surface-mount packages, and is specified from -40°C to $+125^\circ\text{C}$.

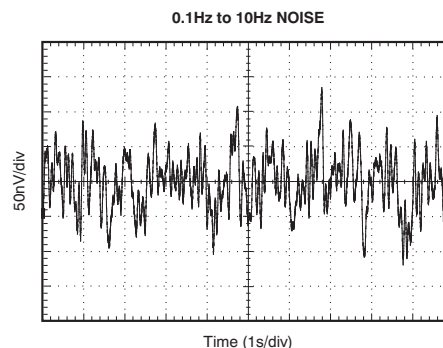
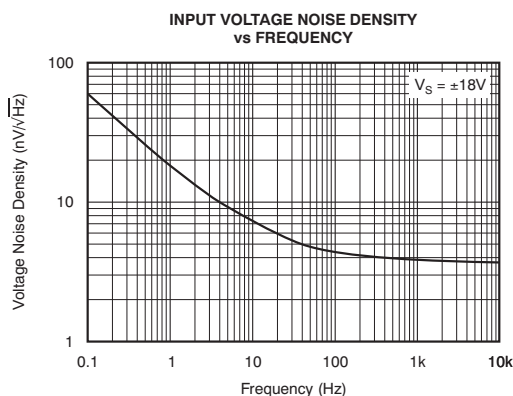

Please be aware that an important notice concerning availability, standard warranty, and use in critical applications of Texas Instruments semiconductor products and disclaimers thereto appears at the end of this data sheet.

All trademarks are the property of their respective owners.



This integrated circuit can be damaged by ESD. Texas Instruments recommends that all integrated circuits be handled with appropriate precautions. Failure to observe proper handling and installation procedures can cause damage.

ESD damage can range from subtle performance degradation to complete device failure. Precision integrated circuits may be more susceptible to damage because very small parametric changes could cause the device not to meet its published specifications.

PACKAGE/ORDERING INFORMATION⁽¹⁾

PRODUCT	PACKAGE-LEAD	PACKAGE DESIGNATOR	PACKAGE MARKING
Standard Grade			
OPA827AI	SO-8	D	OPA827A
OPA827AI ⁽²⁾	MSOP-8	DGK	NSP
High Grade			
OPA827I ⁽²⁾	SO-8	D	OPA827
	MSOP-8	DGK	NSP

(1) For the most current package and ordering information see the Package Option Addendum at the end of this document, or see the TI web site at www.ti.com.

(2) Shaded cells indicate product preview devices.

ABSOLUTE MAXIMUM RATINGS⁽¹⁾

Over operating free-air temperature range (unless otherwise noted).

PARAMETER	VALUE	UNIT	
Supply Voltage	$V_S = (V+) - (V-)$	40	V
Input Voltage ⁽²⁾	$(V-) - 0.5$ to $(V+) + 0.5$		V
Input Current ⁽²⁾	± 10		mA
Differential Input Voltage	$\pm V_S$		V
Output Short-Circuit ⁽³⁾	Continuous		
Operating Temperature	T_A	-55 to +150	°C
Storage Temperature	T_A	-65 to +150	°C
Junction Temperature	T_J	+150	°C
ESD Ratings	Human Body Model (HBM)	4000	V
	Charged Device Model (CDM)	1000	V

- (1) Stresses above these ratings may cause permanent damage. Exposure to absolute maximum conditions for extended periods may degrade device reliability. These are stress ratings only, and functional operation of the device at these or any other conditions beyond those specified is not supported.
- (2) Input terminals are diode-clamped to the power-supply rails. Input signals that can swing more than 0.5V beyond the supply rails should be current-limited to 10mA or less.
- (3) Short-circuit to $V_S/2$ (ground in symmetrical dual-supply setups).

ELECTRICAL CHARACTERISTICS: $V_S = \pm 4V$ to $\pm 18V$
Boldface limits apply over the specified temperature range, $T_A = -40^\circ\text{C}$ to $+125^\circ\text{C}$.

 At $T_A = +25^\circ\text{C}$, $R_L = 10\text{k}\Omega$ connected to midsupply, $V_{CM} = V_{OUT} = \text{midsupply}$, unless otherwise noted.

PARAMETER	CONDITIONS	STANDARD GRADE OPA827AI			HIGH GRADE OPA827J ⁽¹⁾⁽²⁾			UNIT
		MIN	TYP	MAX	MIN	TYP	MAX	
OFFSET VOLTAGE								
Input Offset Voltage	V_{OS}	$V_S = \pm 15V, V_{CM} = 0V$		75	150	50	75	μV
Drift	dV_{OS}/dT			1.5		1.5		$\mu\text{V}/^\circ\text{C}$
vs Power Supply	PSRR			0.2	1	0.2	1	$\mu\text{V}/\text{V}$
Over Temperature				3		3		$\mu\text{V}/\text{V}$
INPUT BIAS CURRENT								
Input Bias Current	I_B	-40°C to $+85^\circ\text{C}$		± 15	± 50	± 15	± 50	pA
Over Temperature		-40°C to $+125^\circ\text{C}$			± 50		± 50	nA
Input Offset Current	I_{OS}			± 10	± 50	± 10	± 50	pA
NOISE								
Input Voltage Noise:								
$f = 0.1\text{Hz}$ to 10Hz	e_n	$V_S = \pm 18V, V_{CM} = 0V$		250		250		nV_{PP}
Input Voltage Noise Density:								
$f = 1\text{kHz}$	e_n	$V_S = \pm 18V, V_{CM} = 0V$		4		4		$\text{nV}/\sqrt{\text{Hz}}$
$f = 10\text{kHz}$	e_n	$V_S = \pm 18V, V_{CM} = 0V$		3.8		3.8		$\text{nV}/\sqrt{\text{Hz}}$
Input Current Noise Density:								
$f = 1\text{kHz}$	i_n	$V_S = \pm 18V, V_{CM} = 0V$		2.2		2.2		$\text{fA}/\sqrt{\text{Hz}}$
INPUT VOLTAGE RANGE								
Common-Mode Voltage Range	V_{CM}			$(V-)+3$		$(V-)+3$		V
Common-Mode Rejection Ratio	CMRR	$(V-)+3V \leq V_{CM} \leq (V+)-3V, V_S < 10V$		104	114	114	120	dB
		$(V-)+3V \leq V_{CM} \leq (V+)-3V, V_S \geq 10V$		114	126	120	126	dB
Over Temperature		$(V-)+3V \leq V_{CM} \leq (V+)-3V, V_S < 10V$		100		100		dB
		$(V-)+3V \leq V_{CM} \leq (V+)-3V, V_S \geq 10V$		110		110		dB
INPUT IMPEDANCE								
Differential				$10^{13} \parallel 9$		$10^{13} \parallel 9$		$\Omega \parallel \text{pF}$
Common-Mode				$10^{13} \parallel 9$		$10^{13} \parallel 9$		$\Omega \parallel \text{pF}$
OPEN-LOOP GAIN								
Open-Loop Voltage Gain	A_{OL}	$(V-)+3V \leq V_O \leq (V+)-3V, R_L = 1\text{k}\Omega$		120	126	120	126	dB
Over Temperature		$(V-)+3V \leq V_O \leq (V+)-3V, R_L = 1\text{k}\Omega$		114		114		dB
FREQUENCY RESPONSE								
Gain-Bandwidth Product	GBW	$G = +1$		22		22		MHz
Slew Rate	SR	$G = -1$		28		28		$\text{V}/\mu\text{s}$
Settling Time, $\pm 0.01\%$	t_s	10V Step, $G = -1, C_L = 100\text{pF}$		550		550		ns
0.00075% (16-bit)		10V Step, $G = -1, C_L = 100\text{pF}$		850		850		ns
Overload Recovery Time		Gain = -10		150		150		ns
Total Harmonic Distortion + Noise	THD+N	$G = +1, f = 1\text{kHz}$		0.00004		0.00004		%
		$V_O = 3V_{RMS}, R_L = 600\Omega$		-128		-128		dB

 (1) **Shaded cells** indicate different specifications from standard grade version of device.

(2) High-grade specifications are preview only.

ELECTRICAL CHARACTERISTICS: $V_S = \pm 4V$ to $\pm 18V$ (continued)

Boldface limits apply over the specified temperature range, $T_A = -40^\circ C$ to $+125^\circ C$.

At $T_A = +25^\circ C$, $R_L = 10k\Omega$ connected to midsupply, $V_{CM} = V_{OUT} =$ midsupply, unless otherwise noted.

PARAMETER	CONDITIONS	STANDARD GRADE OPA827AI			HIGH GRADE OPA827I ⁽¹⁾⁽²⁾			UNIT
		MIN	TYP	MAX	MIN	TYP	MAX	
OUTPUT								
Voltage Output Swing	$R_L = 1k\Omega, A_{OL} > 120dB$ $R_L = 1k\Omega, A_{OL} > 114dB$ $ V_S - V_{OUT} < 3V$	(V-)+3		(V+)-3	(V-)+3		(V+)-3	V
Over Temperature		(V-)+3		(V+)-3	(V-)+3		(V+)-3	V
Output Current I_{OUT}		30			30			mA
Short-Circuit Current I_{SC}		± 65			± 65			mA
Capacitive Load Drive C_{LOAD}		See Typical Characteristics						
Open-Loop Output Impedance Z_O	See Typical Characteristics							
POWER SUPPLY								
Specified Voltage V_S	$I_{OUT} = 0A$	± 4		± 18	± 4		± 18	V
Quiescent Current (per amplifier) I_Q		4.8		5.2	4.8		5.2	mA
Over Temperature				6			6	mA
TEMPERATURE RANGE								
Specified Range T_A		-40		+125	-40		+125	$^\circ C$
Operating Range T_A		-55		+150	-55		+150	$^\circ C$
Thermal Resistance θ_{JA}								$^\circ C/W$
SO-8, MSOP-8 ⁽³⁾			150			150		

(3) MSOP-8 (DGK) package is product preview.

PIN CONFIGURATION

D, DGK⁽¹⁾ PACKAGES
SO-8, MSOP-8⁽¹⁾
(TOP VIEW)

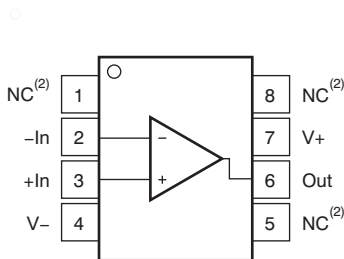

(1) MSOP-8 (DGK) package is product preview.
(2) NC denotes no internal connection.

TYPICAL CHARACTERISTICS: $V_S = \pm 18V$

At $T_A = +25^\circ C$, $R_L = 10k\Omega$ connected to midsupply, $V_{CM} = V_{OUT} =$ midsupply, unless otherwise noted.

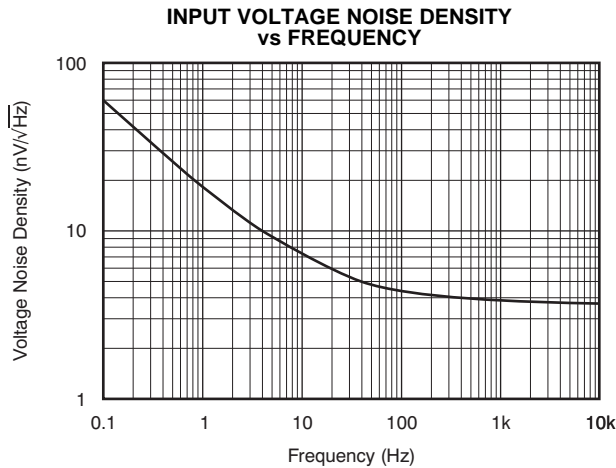

Figure 1.

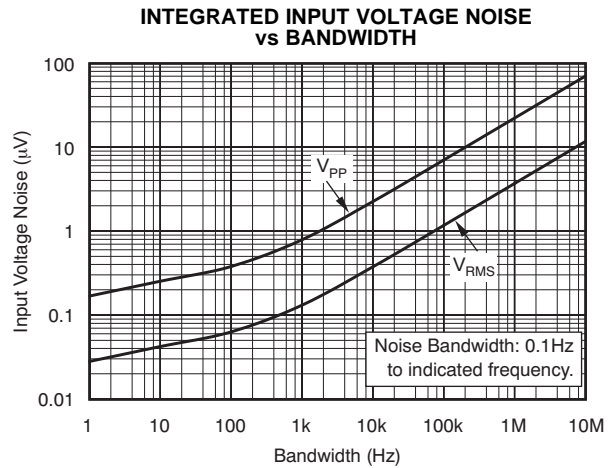

Figure 2.

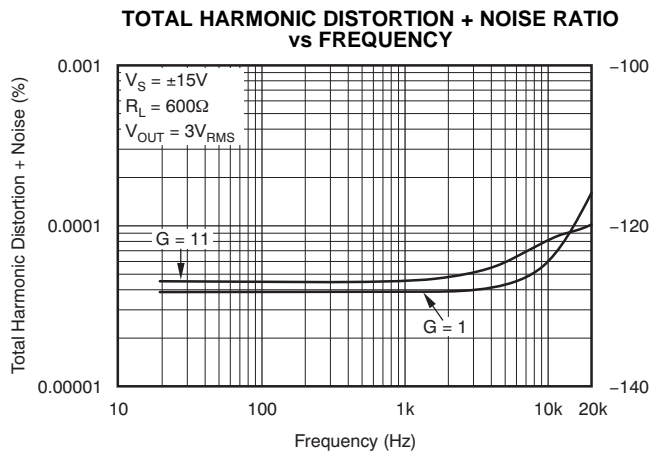

Figure 3.

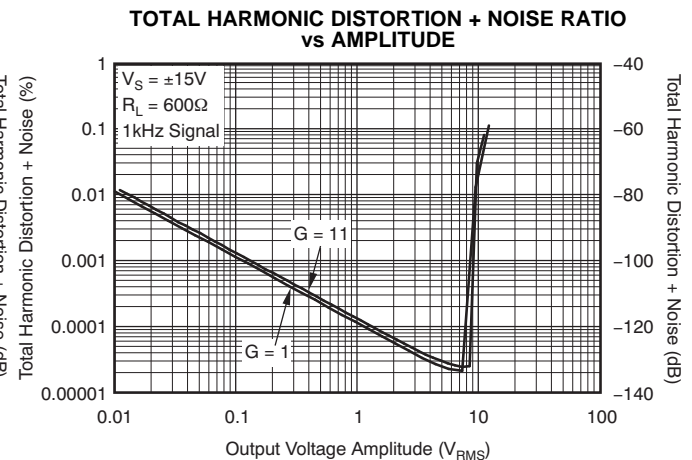

Figure 4.

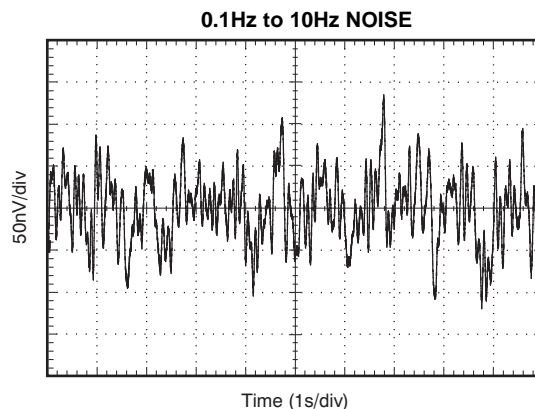

Figure 5.

TYPICAL CHARACTERISTICS: $V_S = \pm 18V$ (continued)

At $T_A = +25^\circ C$, $R_L = 10k\Omega$ connected to midsupply, $V_{CM} = V_{OUT} =$ midsupply, unless otherwise noted.

OFFSET VOLTAGE PRODUCTION DISTRIBUTION

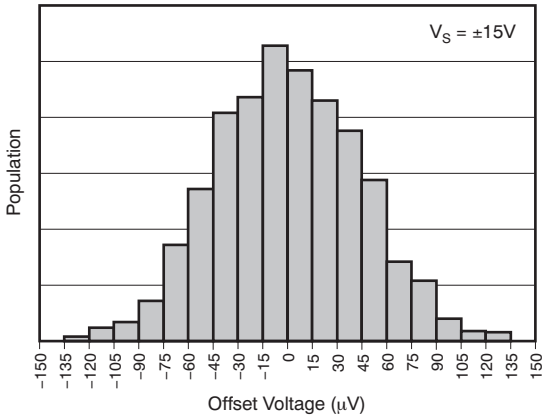

Figure 6.

OFFSET VOLTAGE DRIFT PRODUCTION DISTRIBUTION

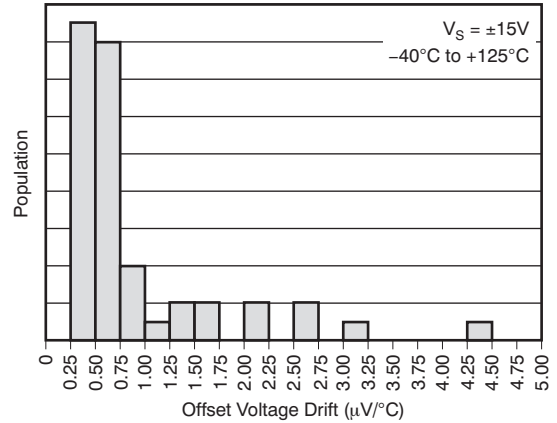

Figure 7.

OFFSET VOLTAGE vs COMMON-MODE VOLTAGE

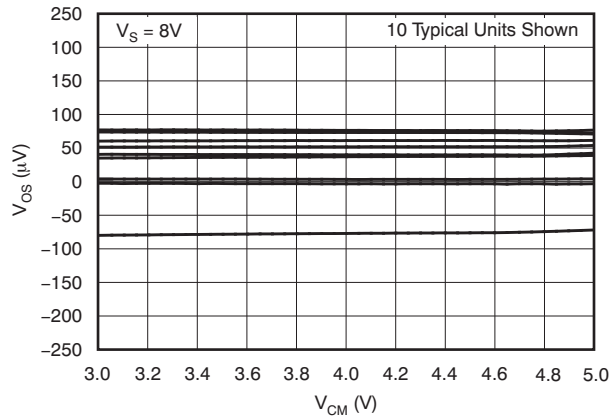

Figure 8.

OFFSET VOLTAGE vs COMMON-MODE VOLTAGE

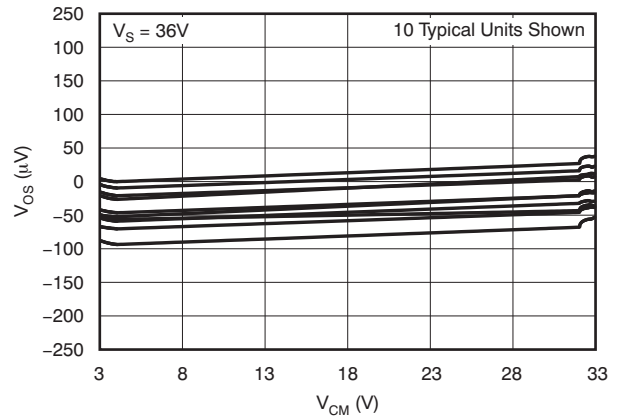

Figure 9.

V_{OS} WARMUP

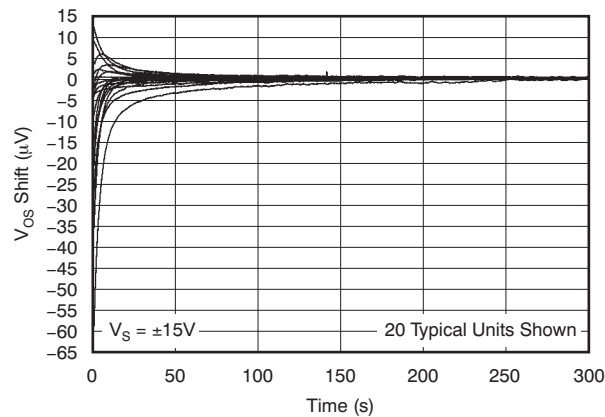

Figure 10.

OFFSET VOLTAGE DRIFT vs TEMPERATURE

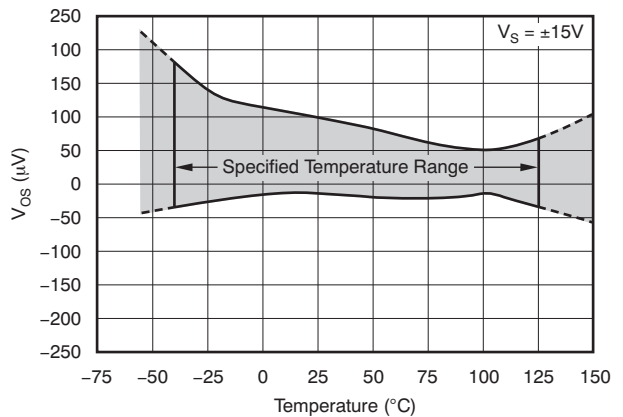

Figure 11.

TYPICAL CHARACTERISTICS: $V_S = \pm 18V$ (continued)

At $T_A = +25^\circ C$, $R_L = 10k\Omega$ connected to midsupply, $V_{CM} = V_{OUT} =$ midsupply, unless otherwise noted.

INPUT BIAS CURRENT AND OFFSET CURRENT vs SUPPLY VOLTAGE

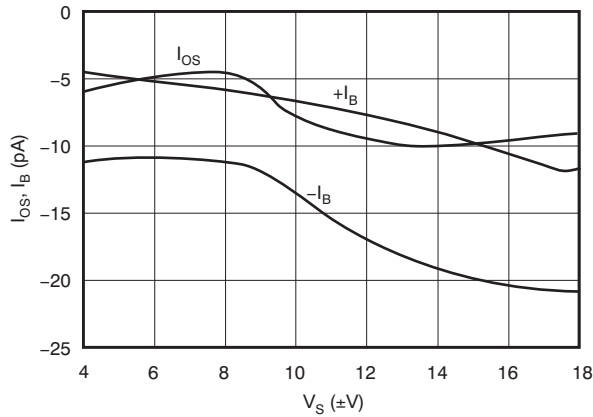

Figure 12.

INPUT BIAS CURRENT vs COMMON-MODE VOLTAGE

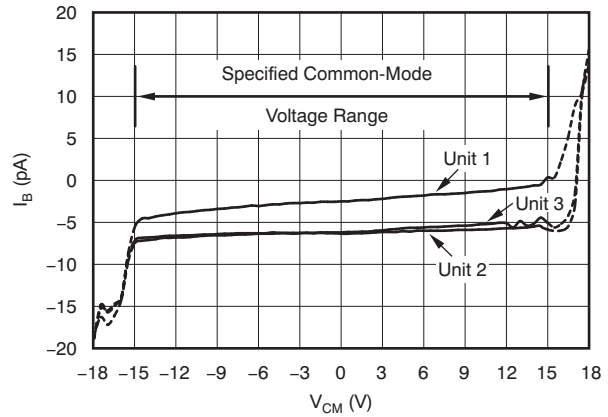

Figure 13.

INPUT BIAS CURRENT vs TEMPERATURE

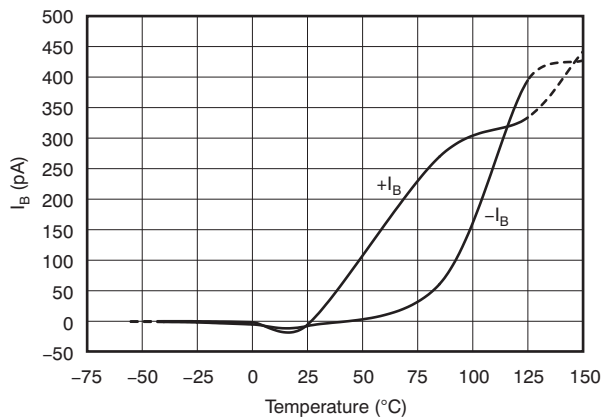

Figure 14.

NORMALIZED QUIESCENT CURRENT vs TIME

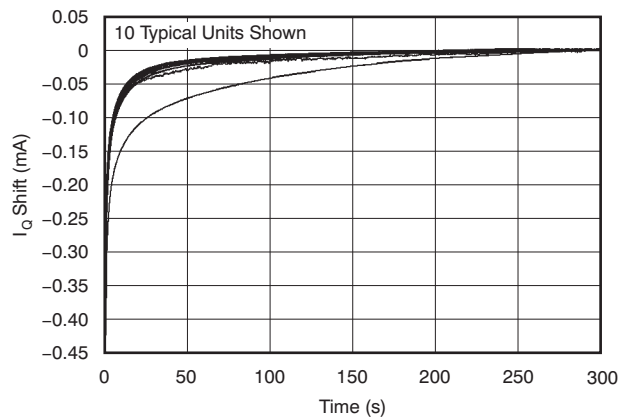

Figure 15.

QUIESCENT CURRENT vs TEMPERATURE

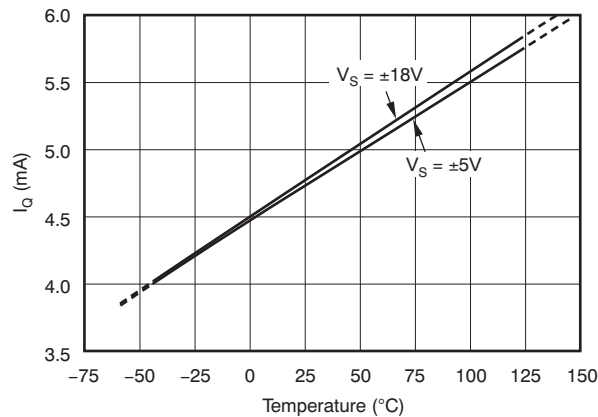

Figure 16.

QUIESCENT CURRENT vs SUPPLY VOLTAGE

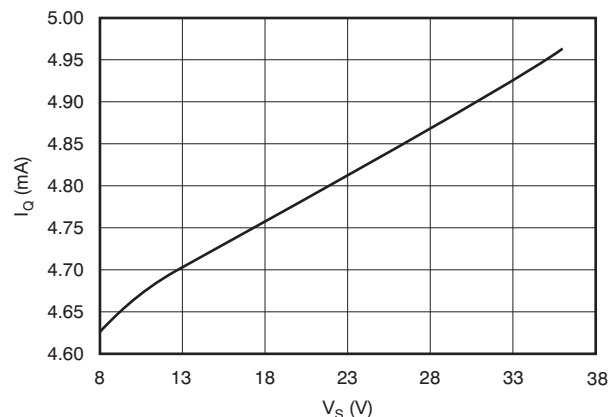

Figure 17.

TYPICAL CHARACTERISTICS: $V_S = \pm 18V$ (continued)

At $T_A = +25^\circ C$, $R_L = 10k\Omega$ connected to midsupply, $V_{CM} = V_{OUT} =$ midsupply, unless otherwise noted.

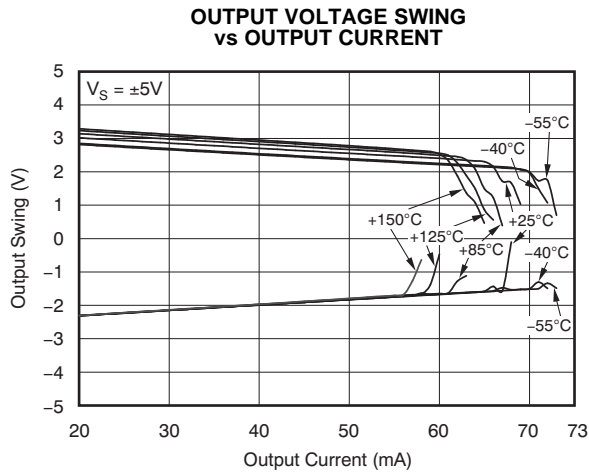

Figure 18.

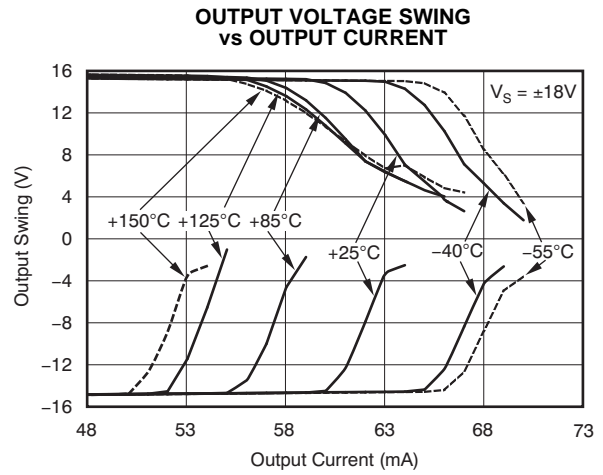

Figure 19.

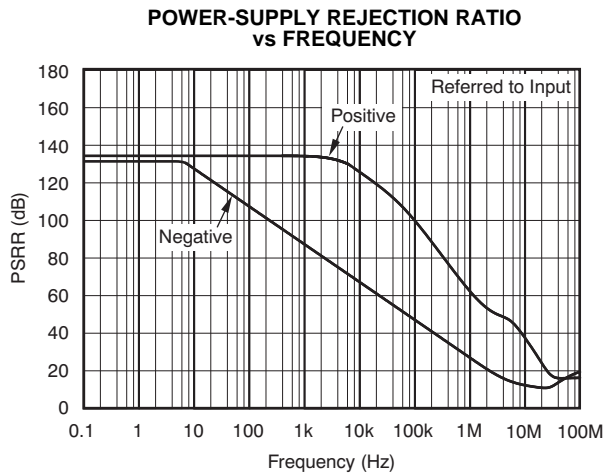

Figure 20.

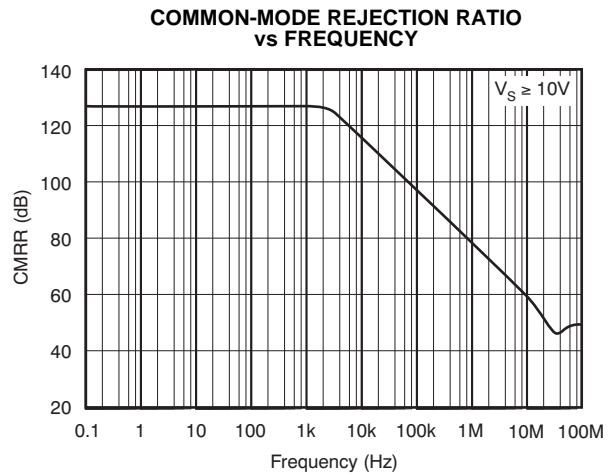

Figure 21.

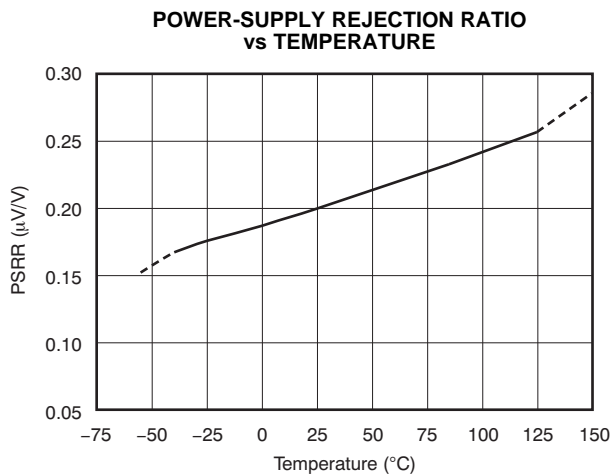

Figure 22.

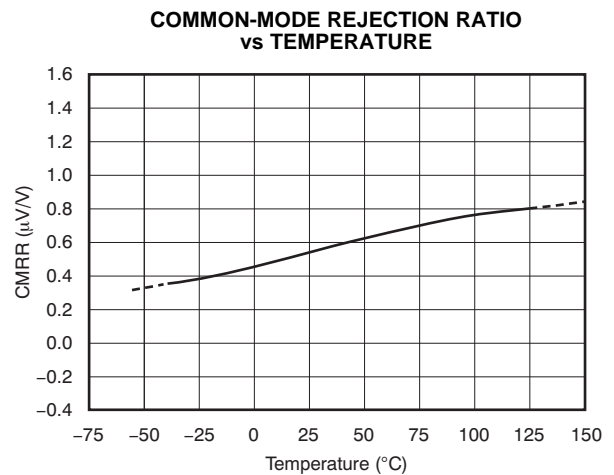

Figure 23.

TYPICAL CHARACTERISTICS: $V_S = \pm 18V$ (continued)

At $T_A = +25^\circ C$, $R_L = 10k\Omega$ connected to midsupply, $V_{CM} = V_{OUT} =$ midsupply, unless otherwise noted.

OPEN-LOOP GAIN AND PHASE vs FREQUENCY

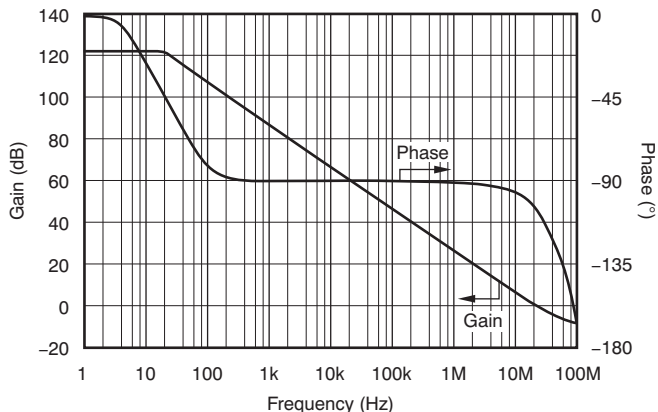

Figure 24.

CLOSED-LOOP GAIN vs FREQUENCY

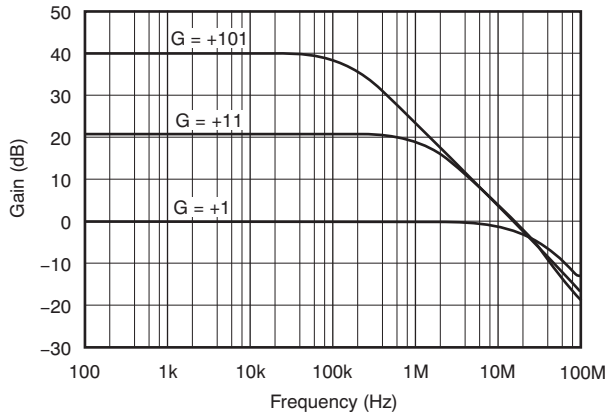

Figure 25.

OPEN-LOOP GAIN vs TEMPERATURE

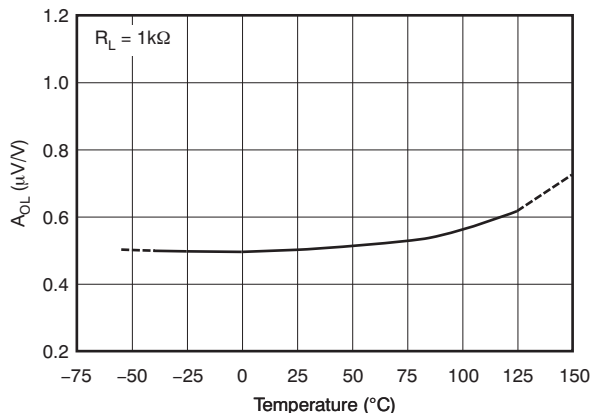

Figure 26.

OPEN-LOOP OUTPUT IMPEDANCE vs FREQUENCY

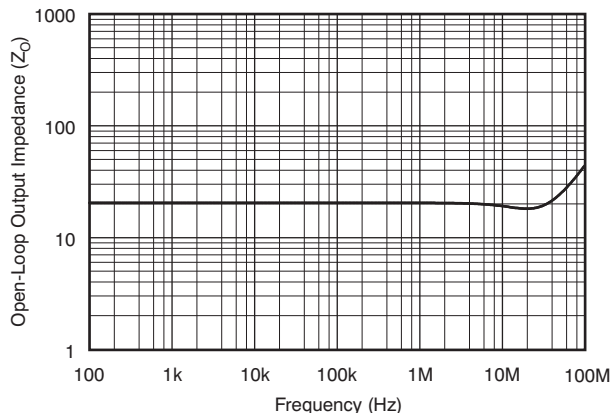

Figure 27.

SMALL-SIGNAL OVERSHOOT vs CAPACITIVE LOAD

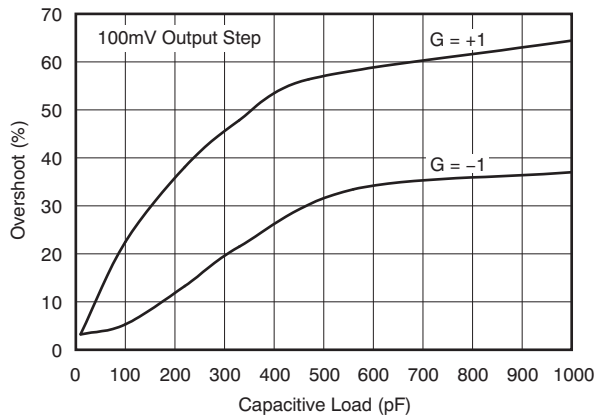

Figure 28.

NO PHASE REVERSAL

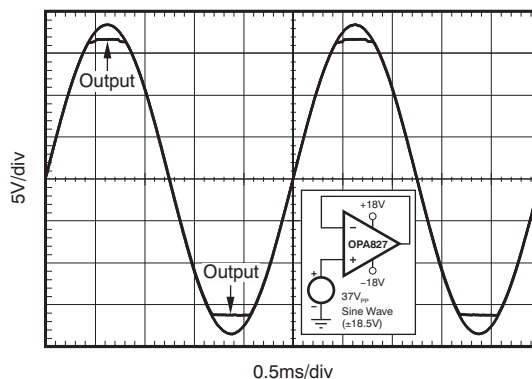

Figure 29.

TYPICAL CHARACTERISTICS: $V_S = \pm 18V$ (continued)

At $T_A = +25^\circ C$, $R_L = 10k\Omega$ connected to midsupply, $V_{CM} = V_{OUT} =$ midsupply, unless otherwise noted.

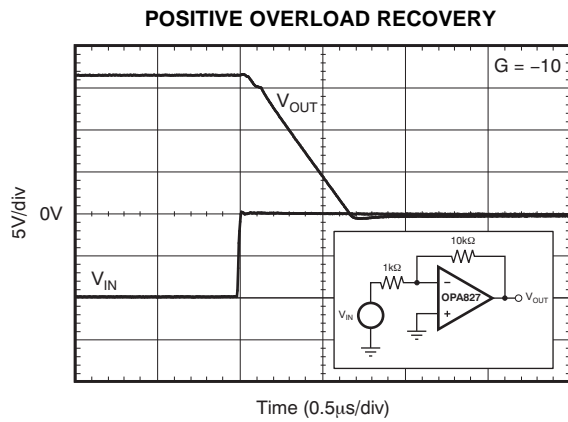

Figure 30.

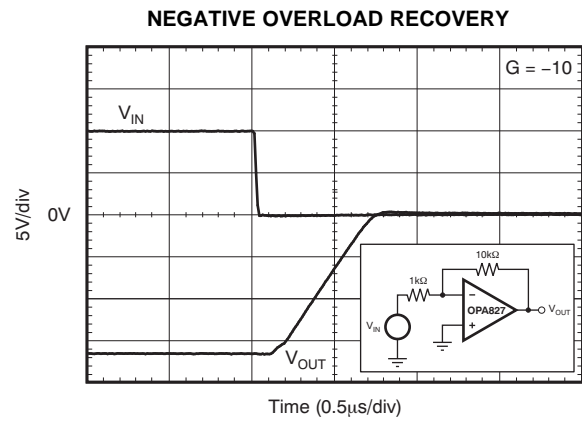

Figure 31.

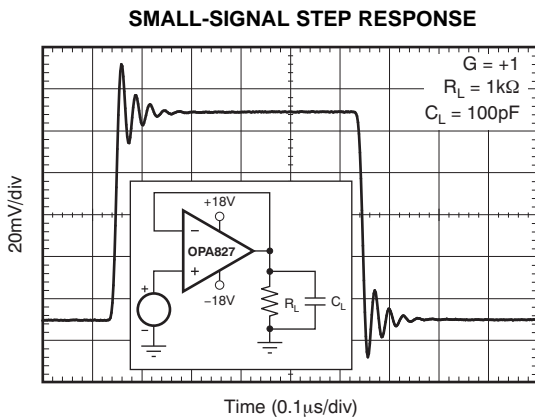

Figure 32.

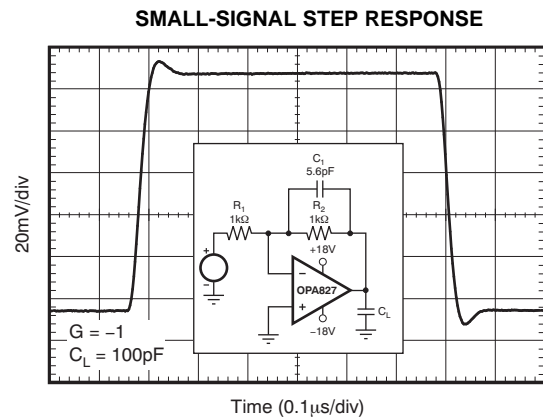

Figure 33.

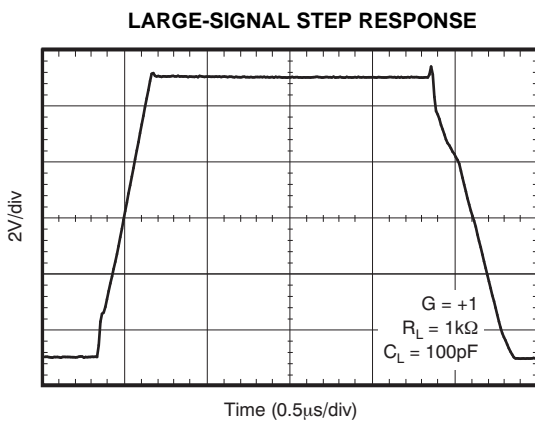

Figure 34.

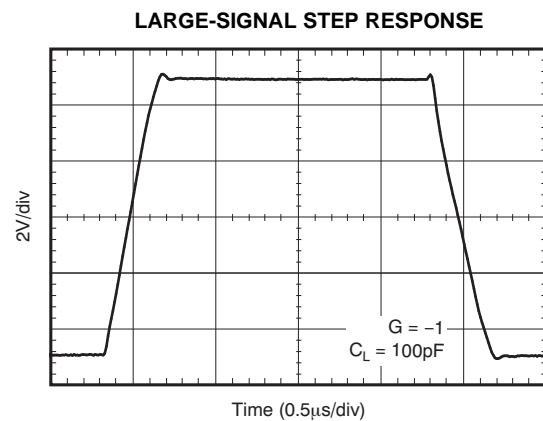

Figure 35.

TYPICAL CHARACTERISTICS: $V_S = \pm 18V$ (continued)

At $T_A = +25^\circ C$, $R_L = 10k\Omega$ connected to midsupply, $V_{CM} = V_{OUT} =$ midsupply, unless otherwise noted.

LARGE-SIGNAL POSITIVE SETTLING TIME
($10V_{PP}$, $C_L = 100pF$)

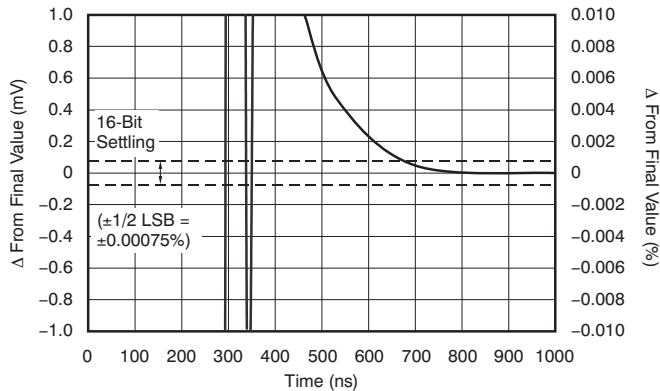

Figure 36.

LARGE-SIGNAL POSITIVE SETTLING TIME
($10V_{PP}$, $C_L = 10pF$)

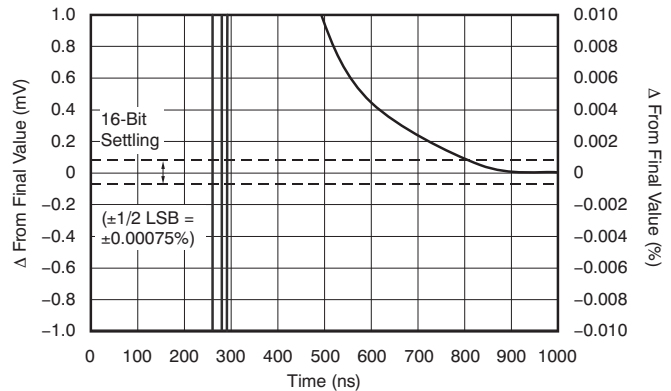

Figure 37.

LARGE-SIGNAL NEGATIVE SETTLING TIME
($10V_{PP}$, $C_L = 100pF$)

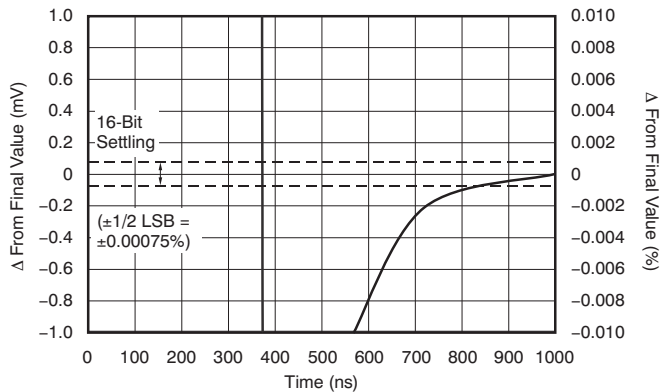

Figure 38.

LARGE-SIGNAL NEGATIVE SETTLING TIME
($10V_{PP}$, $C_L = 10pF$)

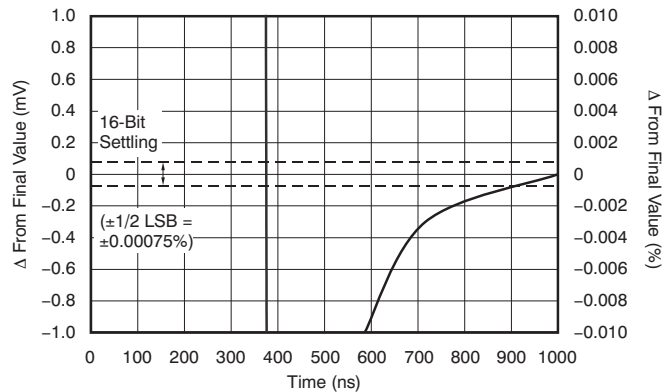

Figure 39.

SHORT-CIRCUIT CURRENT vs TEMPERATURE

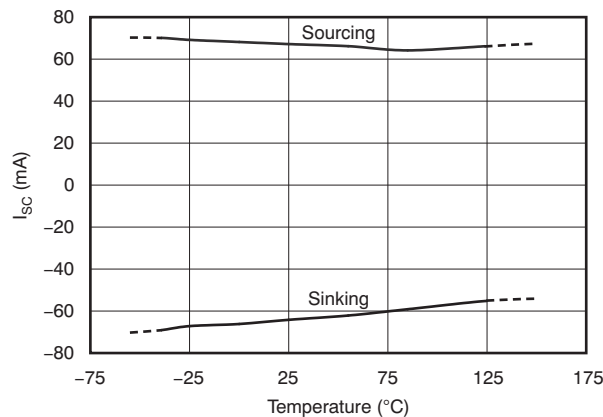

Figure 40.

APPLICATION INFORMATION

The OPA827 is a unity-gain stable, precision operational amplifier with very low noise, input bias current, and input offset voltage. Applications with noisy or high impedance power supplies require decoupling capacitors placed close to the device pins. In most cases, 0.1µF capacitors are adequate.

OPERATING VOLTAGE

The OPA827 series of op amps can be used with single or dual supplies from an operating range of $V_S = +8V (\pm 4V)$ and up to $V_S = +36V (\pm 18V)$. This device does not require symmetrical supplies; it only requires a minimum supply voltage of 8V. Supply voltages higher than +40V ($\pm 20V$) can permanently damage the device; see the [Absolute Maximum Ratings](#) table. Key parameters are specified over the operating temperature range, $T_A = -40^\circ\text{C}$ to $+125^\circ\text{C}$. Key parameters that vary over the supply voltage or temperature range are shown in the [Typical Characteristics](#) section of this data sheet.

NOISE PERFORMANCE

Figure 41 shows the total circuit noise for varying source impedances with the operational amplifier in a unity-gain configuration (with no feedback resistor network and therefore no additional noise contributions). The OPA827 (GBW = 22MHz) and OPA211 (GBW = 80MHz) are both shown in this example with total circuit noise calculated. The op amp itself contributes both a voltage noise component and a current noise component. The voltage noise is commonly modeled as a time-varying component of the offset voltage. The current noise is modeled as the time-varying component of the input bias current and reacts with the source resistance to create a voltage component of noise. Therefore, the lowest noise op amp for a given application depends on the source impedance. For low source impedance, current noise is negligible, and voltage noise generally dominates. The OPA827 family has both low voltage noise and lower current noise because of the FET input of the op amp. Very low current noise allows for excellent noise performance with source impedances greater than 10kΩ. The OPA211 has lower voltage noise and higher current noise. The low voltage noise makes the OPA211 a better choice for low source impedances (less than 2kΩ). For high source impedance, current noise may dominate, and makes the OPA827 series amplifier the better choice.

The equation in Figure 41 shows the calculation of the total circuit noise, with these parameters:

- e_n = voltage noise
- i_n = current noise
- R_S = source impedance
- k = Boltzmann's constant = 1.38×10^{-23} J/K
- T = temperature in kelvins

For more details on calculating noise, see the [Basic Noise Calculations](#) section.

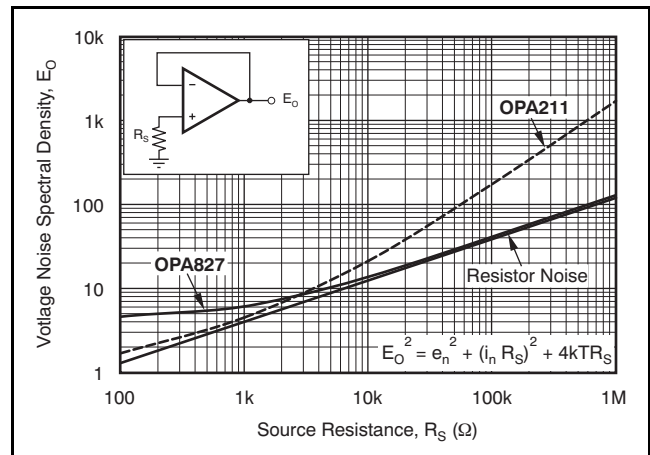

Figure 41. Noise Performance of the OPA827 and OPA211 in Unity-Gain Buffer Configuration

BASIC NOISE CALCULATIONS

Low-noise circuit design requires careful analysis of all noise sources. External noise sources can dominate in many cases; consider the effect of source resistance on overall op amp noise performance. Total noise of the circuit is the root-sum-square combination of all noise components.

The resistive portion of the source impedance produces thermal noise proportional to the square root of the resistance. This function is plotted in Figure 41. The source impedance is usually fixed; consequently, select the op amp and the feedback resistors to minimize the respective contributions to the total noise.

Figure 42 illustrates both noninverting (A) and inverting (B) op amp circuit configurations with gain. In circuit configurations with gain, the feedback network resistors also contribute noise. The current noise of the op amp reacts with the feedback resistors to create additional noise components.

The feedback resistor values can generally be chosen to make these noise sources negligible. Note that low impedance feedback resistors will load the output of the amplifier. The equations for total noise are shown for both configurations.

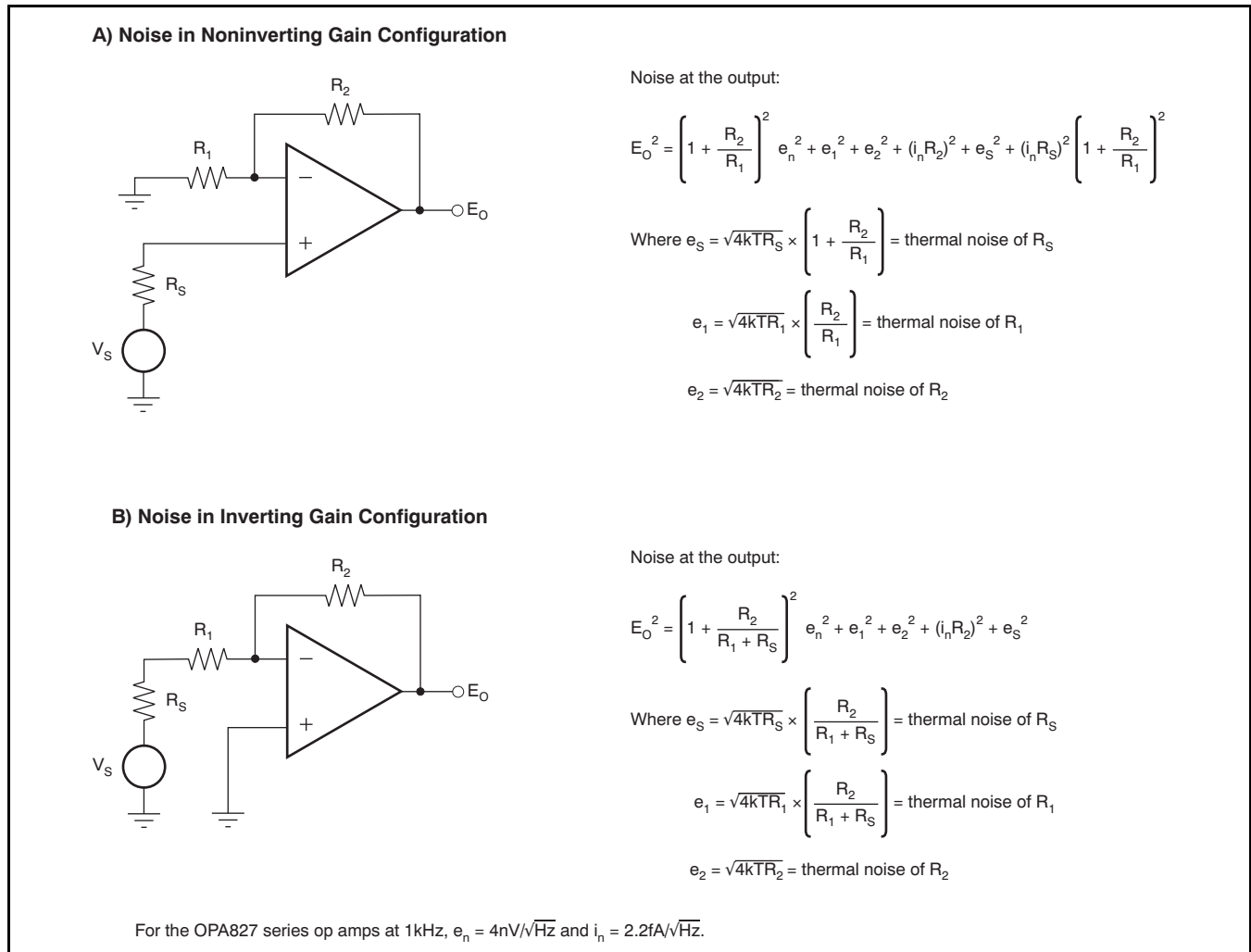

Figure 42. Noise Calculation in Gain Configurations

TOTAL HARMONIC DISTORTION MEASUREMENTS

The OPA827 series op amps have excellent distortion characteristics. THD + Noise is below 0.0001% ($G = +1$, $V_O = 3V_{RMS}$) throughout the audio frequency range, 20Hz to 20kHz, with a 600Ω load (see Figure 3).

The distortion produced by the OPA827 series is below the measurement limit of many commercially available testers. However, a special test circuit (illustrated in Figure 43) can be used to extend the measurement capabilities.

Op amp distortion can be considered an internal error source that can be referred to the input. Figure 43 shows a circuit that causes the op amp distortion to be 101 times greater than that distortion normally produced by the op amp. The addition of R_3 to the otherwise standard noninverting amplifier configuration alters the feedback factor or noise gain

of the circuit. The closed-loop gain is unchanged, but the feedback available for error correction is reduced by a factor of 101, thus extending the resolution by 101. Note that the input signal and load applied to the op amp are the same as with conventional feedback without R_3 . The value of R_3 should be kept small to minimize its effect on the distortion measurements.

The validity of this technique can be verified by duplicating measurements at high gain and/or high frequency where the distortion is within the measurement capability of the test equipment. Measurements for this data sheet were made with an Audio Precision System Two distortion/noise analyzer, which greatly simplifies such repetitive measurements. This measurement technique, however, can be performed with manual distortion measurement instruments.

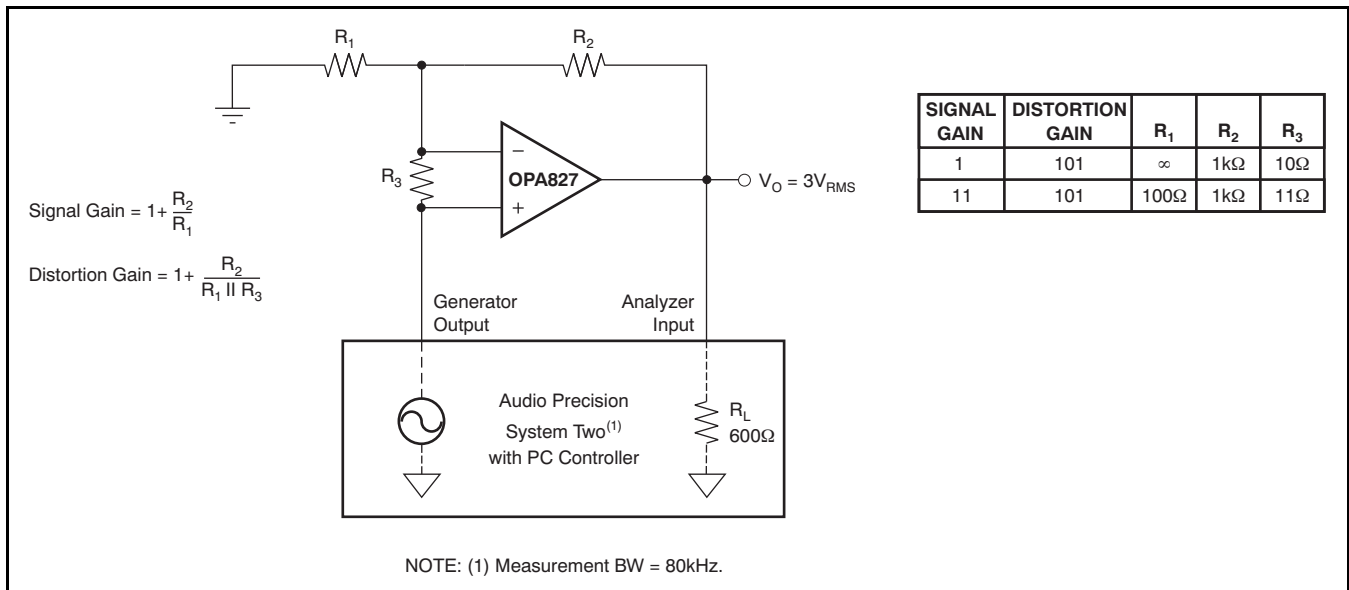

Figure 43. Distortion Test Circuit

CAPACITIVE LOAD AND STABILITY

The combination of gain bandwidth product (GBW) and near constant open loop output impedance (Z_O) over frequency gives the OPA827 the ability to drive large capacitive loads. Figure 44 shows the OPA827 connected in a buffer configuration ($G = +1$) while driving a $2.2\mu\text{F}$ ceramic capacitor (with an ESR value of approximately 0Ω). The small overshoot and fast settling time are results of good phase margin. This feature provides superior performance compared to the competition. Figure 44 and Figure 45 were taken without any resistive load in parallel to shorten the ringing time.

In Figure 45, the OPA827 is driving a $2.2\mu\text{F}$ tantalum capacitor. A relatively small ESR that is internal to the capacitor additionally improves phase margin and provides an output waveform with no ringing and minimal overshoot. Figure 45 shows a stable system that can be used in almost any application.

Capacitive load drive depends on the gain and overshoot requirements of the application. Capacitive loads limit the bandwidth of the amplifier. Increasing the gain enhances the ability of the amplifier to drive greater capacitive loads (see Figure 28).

PHASE-REVERSAL PROTECTION

The OPA827 family has internal phase-reversal protection. Many FET-input op amps exhibit a phase reversal when the input is driven beyond its linear common-mode range. This condition is most often encountered in noninverting circuits when the input is driven beyond the specified common-mode voltage range, causing the output to reverse into the opposite rail. The input circuitry of the OPA827 prevents phase reversal with excessive common-mode voltage; instead, the output limits into the appropriate rail (see Figure 29).

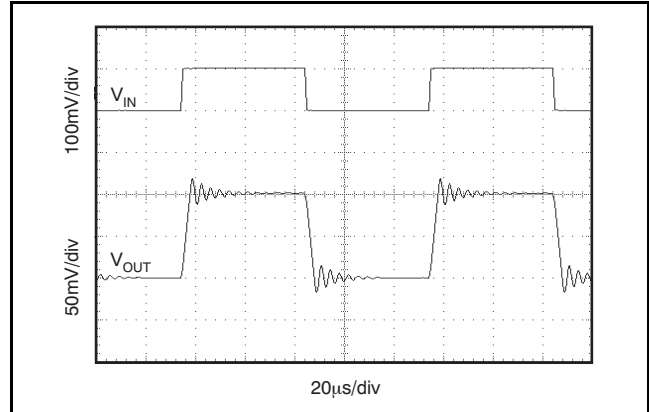

Figure 44. OPA827 Driving $2.2\mu\text{F}$ Ceramic Capacitor

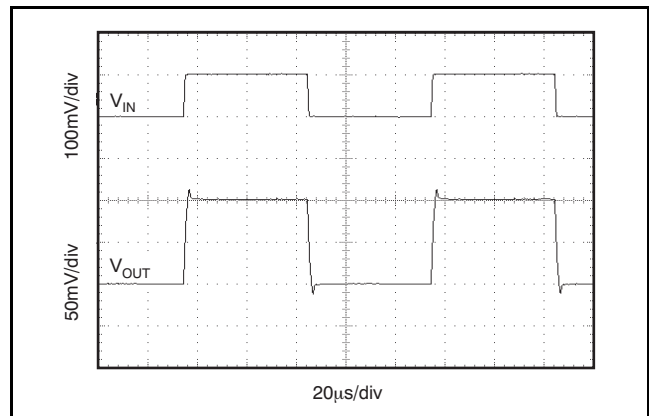

Figure 45. OPA827 Driving $2.2\mu\text{F}$ Tantalum Capacitor

TRANSIMPEDANCE AMPLIFIER

The gain bandwidth, low voltage noise, and current noise of the OPA827 series make them ideal wide bandwidth transimpedance amplifiers in a photo-conductive application. High transimpedance gains with feedback resistors greater than 100kΩ benefit from the low input current noise (2.2fA/Hz) of the JFET input. Low voltage noise is important because photodiode capacitance causes the effective noise gain in the circuit to increase at high frequencies. Total input capacitance of the circuit limits the overall gain bandwidth of the amplifier and is addressed below. Figure 46 shows a photodiode transimpedance application.

Key Transimpedance Points

- The total input capacitance (C_{TOT}) consists of the photodiode junction capacitance, and both the common-mode and differential input capacitance of the operational amplifier.
- The desired transimpedance gain, $V_{OUT} = I_D R_F$.
- The Unity Gain Bandwidth Product (UGBW) (22MHz for the OPA827).

With these three variables set, the feedback capacitor value (C_F) can be calculated to ensure stability. C_{STRAY} is the parasitic capacitance of the PCB and passive components, which is approximately 0.5pF.

To ensure 45° phase margin, the minimal amount of feedback capacitance can be calculated using Equation 1:

$$C_F \left(\frac{1}{4\pi R_F UGBW} \right) \left(1 + \sqrt{1 + (8\pi C_{TOT} R_F UGBW)^2} \right) \tag{1}$$

Bandwidth (f_{-3dB}) calculated by Equation 2:

$$f_{-3dB} = \sqrt{\frac{UGBW}{2\pi R_F (C_{TOT})}} \text{ Hz} \tag{2}$$

These equations result in maximum transimpedance bandwidth. For additional information, refer to Application Bulletin [SBOA055](#), *Compensate Transimpedance Amplifiers Intuitively*, available for download at www.ti.com.

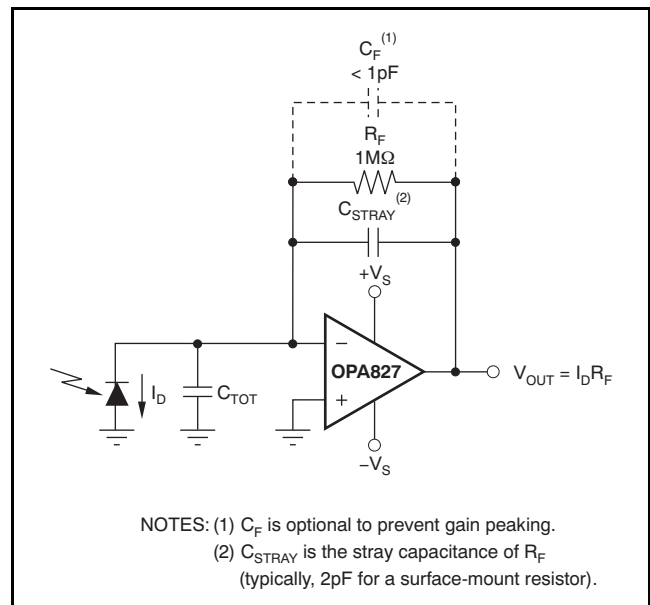

Figure 46. Transimpedance Amplifier

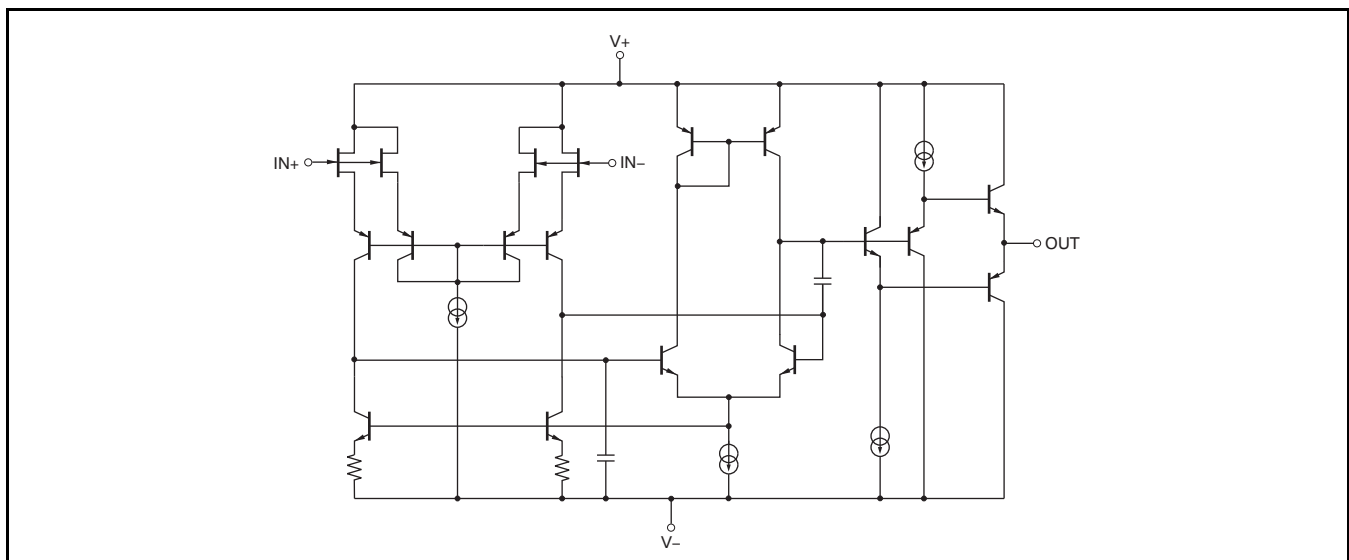

Figure 47. Equivalent Schematic (Single Channel)

PHASE-LOCK LOOP

The OPA827 is well-suited for phase-lock loop (PLL) applications because of the low voltage offset, low noise, and wide gain bandwidth. Figure 48 illustrates an example of the OPA827 in this application. The first amplifier (OPA827) provides the loop low-pass, active filter function, while the second amplifier (OPA211) serves as a scaling amplifier. This second stage amplifies the dc error voltage to the appropriate level before it is applied to the voltage-controlled oscillator (VCO).

Operational amplifiers used in PLL applications are often required to have low voltage offset. As with other dc levels generated in the loop, a voltage offset applied to the VCO is interpreted as a phase error.

An operational amplifier with inherently low voltage offset helps reduce this source of error. Also, any noise produced by the operational amplifiers modulates the voltage applied to the VCO and limits the spectral purity of the oscillator output. The VCO generates noise-related, random phase variations of its own, but this characteristic becomes worse when the input voltage source noise is included. This noise appears as random sideband energy that can limit system performance. The very low flicker noise (1/f) and current noise (I_n) of the OPA827 help to minimize the operational amplifier contribution to the phase noise.

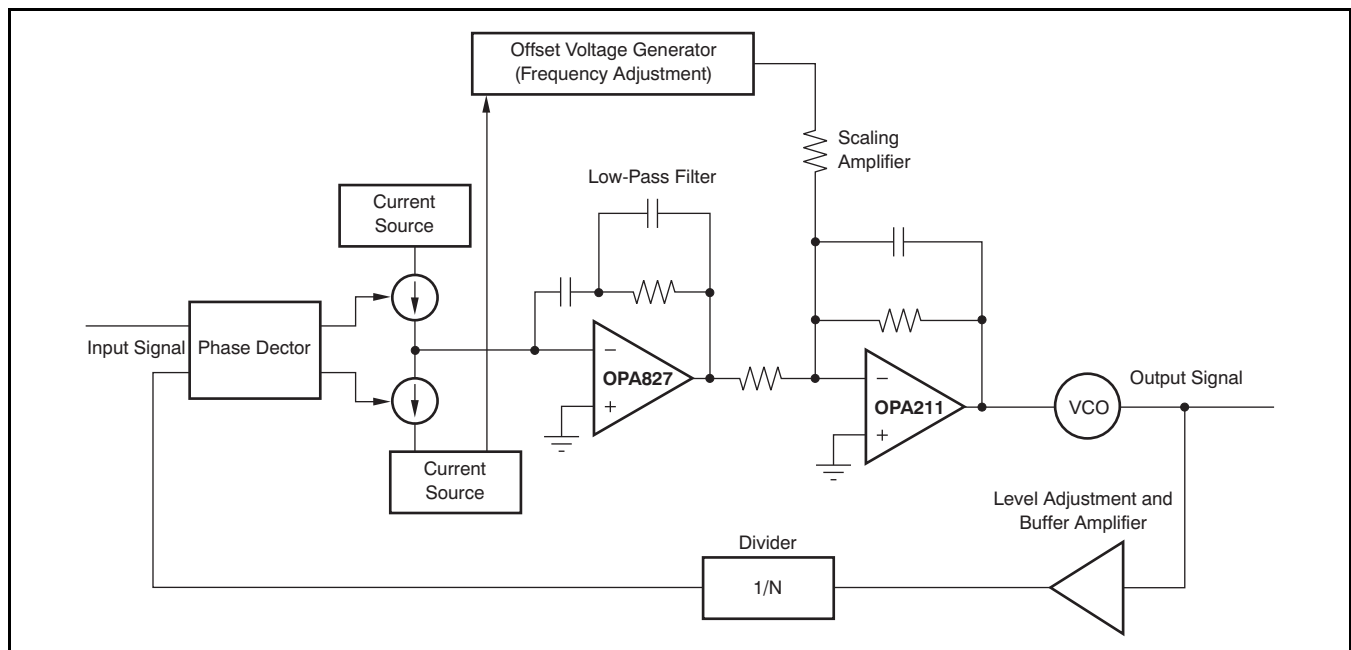

Figure 48. PLL Application

OPA827 USED AS AN I/V CONVERTER

The OPA827 series of operation amplifiers have low current noise and offset voltage that make these devices a great choice for an I/V converter. The DAC8811 is a single channel, current output, 16-bit digital-to-analog converter (DAC). The I_{OUT} terminal of the DAC is held at a virtual GND potential by the use of the OPA827 as an external I/V converter op amp. The R-2R ladder is connected to an external reference input (V_{REF}) that determines the DAC full-scale current. The external reference voltage can vary in a range of $-15V$ to $+15V$, thus providing bipolar I_{OUT} current operation. By using the OPA827 as an external I/V converter in conjunction with the internal DAC8811 R_{FB} resistor, output voltage ranges of $-V_{REF}$ to $+V_{REF}$ can be generated.

When using an external I/V converter and the DAC8811 R_{FB} resistor, the DAC output voltage is given by Equation 3.

$$V_{OUT} = \frac{-V_{REF} \times \text{CODE}}{65536} \quad (3)$$

NOTE: CODE is the digital input into the DAC.

The DAC output impedance as seen looking into the I_{OUT} terminal changes versus code. The low offset voltage of the OPA827 minimizes the error propagated from the DAC.

For a current-to-voltage design (see Figure 49), the DAC8811 I_{OUT} pin and the inverting node of the OPA827 should be as short as possible and adhere to good PCB layout design. For each code change on the output of the DAC, there is a step function. If the parasitic capacitance is excessive at the inverting node, then gain peaking is possible. For circuit stability, two compensation capacitors, C_1 and C_2 (4pF to 20pF typical) can be added to the design.

Some applications require full four-quadrant multiplying capabilities or a bipolar output swing. As shown in Figure 49, the OPA827 is added as a summing amp and has a gain of 2x that widens the output span to 20V. A four-quadrant multiplying circuit is implemented by using a 10V offset of the reference voltage to bias the OPA827.

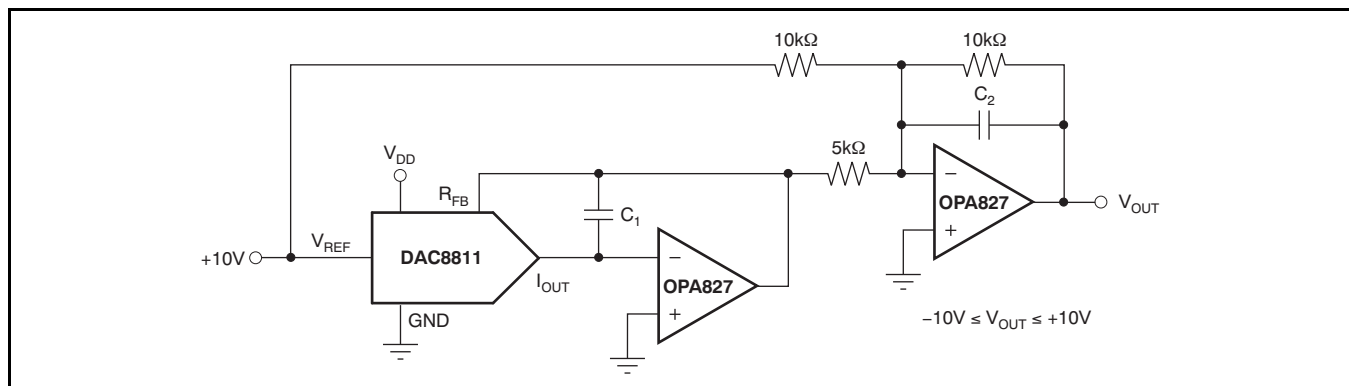

Figure 49. I/V Converter

PACKAGING INFORMATION

Orderable Device	Status ⁽¹⁾	Package Type	Package Drawing	Pins	Package Qty	Eco Plan ⁽²⁾	Lead/Ball Finish	MSL Peak Temp ⁽³⁾
OPA827AID	ACTIVE	SOIC	D	8	75	Green (RoHS & no Sb/Br)	CU NIPDAU	Level-2-260C-UNLIM
OPA827AIDG4	ACTIVE	SOIC	D	8	75	Green (RoHS & no Sb/Br)	CU NIPDAU	Level-2-260C-UNLIM
OPA827AIDR	ACTIVE	SOIC	D	8	2500	Green (RoHS & no Sb/Br)	CU NIPDAU	Level-2-260C-1 YEAR
OPA827AIDRG4	ACTIVE	SOIC	D	8	2500	Green (RoHS & no Sb/Br)	CU NIPDAU	Level-2-260C-1 YEAR

⁽¹⁾ The marketing status values are defined as follows:

ACTIVE: Product device recommended for new designs.

LIFEBUY: TI has announced that the device will be discontinued, and a lifetime-buy period is in effect.

NRND: Not recommended for new designs. Device is in production to support existing customers, but TI does not recommend using this part in a new design.

PREVIEW: Device has been announced but is not in production. Samples may or may not be available.

OBSOLETE: TI has discontinued the production of the device.

⁽²⁾ Eco Plan - The planned eco-friendly classification: Pb-Free (RoHS), Pb-Free (RoHS Exempt), or Green (RoHS & no Sb/Br) - please check <http://www.ti.com/productcontent> for the latest availability information and additional product content details.

TBD: The Pb-Free/Green conversion plan has not been defined.

Pb-Free (RoHS): TI's terms "Lead-Free" or "Pb-Free" mean semiconductor products that are compatible with the current RoHS requirements for all 6 substances, including the requirement that lead not exceed 0.1% by weight in homogeneous materials. Where designed to be soldered at high temperatures, TI Pb-Free products are suitable for use in specified lead-free processes.

Pb-Free (RoHS Exempt): This component has a RoHS exemption for either 1) lead-based flip-chip solder bumps used between the die and package, or 2) lead-based die adhesive used between the die and leadframe. The component is otherwise considered Pb-Free (RoHS compatible) as defined above.

Green (RoHS & no Sb/Br): TI defines "Green" to mean Pb-Free (RoHS compatible), and free of Bromine (Br) and Antimony (Sb) based flame retardants (Br or Sb do not exceed 0.1% by weight in homogeneous material)

⁽³⁾ MSL, Peak Temp. -- The Moisture Sensitivity Level rating according to the JEDEC industry standard classifications, and peak solder temperature.

Important Information and Disclaimer:The information provided on this page represents TI's knowledge and belief as of the date that it is provided. TI bases its knowledge and belief on information provided by third parties, and makes no representation or warranty as to the accuracy of such information. Efforts are underway to better integrate information from third parties. TI has taken and continues to take reasonable steps to provide representative and accurate information but may not have conducted destructive testing or chemical analysis on incoming materials and chemicals. TI and TI suppliers consider certain information to be proprietary, and thus CAS numbers and other limited information may not be available for release.

In no event shall TI's liability arising out of such information exceed the total purchase price of the TI part(s) at issue in this document sold by TI to Customer on an annual basis.

TAPE AND REEL INFORMATION



QUADRANT ASSIGNMENTS FOR PIN 1 ORIENTATION IN TAPE

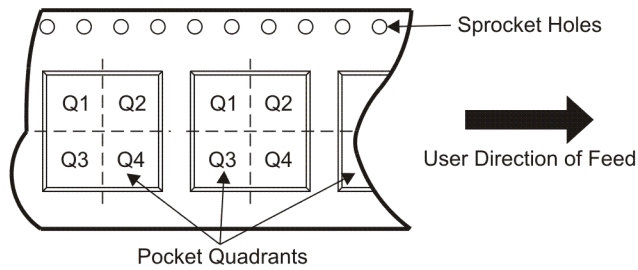

*All dimensions are nominal

Device	Package Type	Package Drawing	Pins	SPQ	Reel Diameter (mm)	Reel Width W1 (mm)	A0 (mm)	B0 (mm)	K0 (mm)	P1 (mm)	W (mm)	Pin1 Quadrant
OPA827AIDR	SOIC	D	8	2500	330.0	12.4	6.4	5.2	2.1	8.0	12.0	Q1

TAPE AND REEL BOX DIMENSIONS



*All dimensions are nominal

Device	Package Type	Package Drawing	Pins	SPQ	Length (mm)	Width (mm)	Height (mm)
OPA827AIDR	SOIC	D	8	2500	346.0	346.0	29.0

DGK (S-PDSO-G8)

PLASTIC SMALL-OUTLINE PACKAGE



- NOTES:
- All linear dimensions are in millimeters.
 - This drawing is subject to change without notice.
 - Body length does not include mold flash, protrusions, or gate burrs. Mold flash, protrusions, or gate burrs shall not exceed 0.15 per end.
 - Body width does not include interlead flash. Interlead flash shall not exceed 0.50 per side.
 - Falls within JEDEC MO-187 variation AA, except interlead flash.

D (R-PDSO-G8)

PLASTIC SMALL-OUTLINE PACKAGE

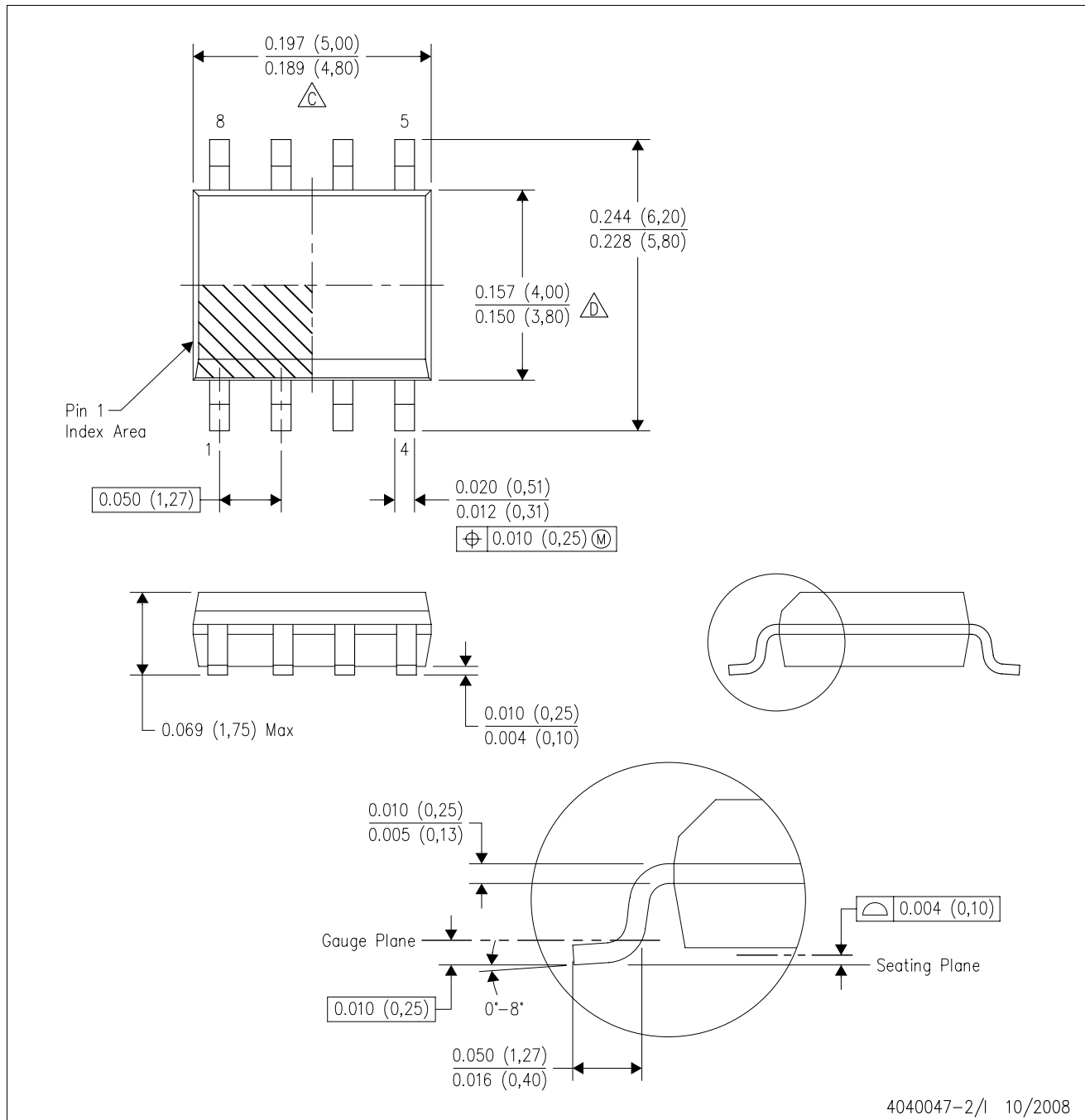

NOTES: A. All linear dimensions are in inches (millimeters).
 B. This drawing is subject to change without notice.
 C. Body length does not include mold flash, protrusions, or gate burrs. Mold flash, protrusions, or gate burrs shall not exceed .006 (0,15) per end.
 D. Body width does not include interlead flash. Interlead flash shall not exceed .017 (0,43) per side.
 E. Reference JEDEC MS-012 variation AA.

IMPORTANT NOTICE

Texas Instruments Incorporated and its subsidiaries (TI) reserve the right to make corrections, modifications, enhancements, improvements, and other changes to its products and services at any time and to discontinue any product or service without notice. Customers should obtain the latest relevant information before placing orders and should verify that such information is current and complete. All products are sold subject to TI's terms and conditions of sale supplied at the time of order acknowledgment.

TI warrants performance of its hardware products to the specifications applicable at the time of sale in accordance with TI's standard warranty. Testing and other quality control techniques are used to the extent TI deems necessary to support this warranty. Except where mandated by government requirements, testing of all parameters of each product is not necessarily performed.

TI assumes no liability for applications assistance or customer product design. Customers are responsible for their products and applications using TI components. To minimize the risks associated with customer products and applications, customers should provide adequate design and operating safeguards.

TI does not warrant or represent that any license, either express or implied, is granted under any TI patent right, copyright, mask work right, or other TI intellectual property right relating to any combination, machine, or process in which TI products or services are used. Information published by TI regarding third-party products or services does not constitute a license from TI to use such products or services or a warranty or endorsement thereof. Use of such information may require a license from a third party under the patents or other intellectual property of the third party, or a license from TI under the patents or other intellectual property of TI.

Reproduction of TI information in TI data books or data sheets is permissible only if reproduction is without alteration and is accompanied by all associated warranties, conditions, limitations, and notices. Reproduction of this information with alteration is an unfair and deceptive business practice. TI is not responsible or liable for such altered documentation. Information of third parties may be subject to additional restrictions.

Resale of TI products or services with statements different from or beyond the parameters stated by TI for that product or service voids all express and any implied warranties for the associated TI product or service and is an unfair and deceptive business practice. TI is not responsible or liable for any such statements.

TI products are not authorized for use in safety-critical applications (such as life support) where a failure of the TI product would reasonably be expected to cause severe personal injury or death, unless officers of the parties have executed an agreement specifically governing such use. Buyers represent that they have all necessary expertise in the safety and regulatory ramifications of their applications, and acknowledge and agree that they are solely responsible for all legal, regulatory and safety-related requirements concerning their products and any use of TI products in such safety-critical applications, notwithstanding any applications-related information or support that may be provided by TI. Further, Buyers must fully indemnify TI and its representatives against any damages arising out of the use of TI products in such safety-critical applications.

TI products are neither designed nor intended for use in military/aerospace applications or environments unless the TI products are specifically designated by TI as military-grade or "enhanced plastic." Only products designated by TI as military-grade meet military specifications. Buyers acknowledge and agree that any such use of TI products which TI has not designated as military-grade is solely at the Buyer's risk, and that they are solely responsible for compliance with all legal and regulatory requirements in connection with such use.

TI products are neither designed nor intended for use in automotive applications or environments unless the specific TI products are designated by TI as compliant with ISO/TS 16949 requirements. Buyers acknowledge and agree that, if they use any non-designated products in automotive applications, TI will not be responsible for any failure to meet such requirements.

Following are URLs where you can obtain information on other Texas Instruments products and application solutions:

Products

Amplifiers	amplifier.ti.com
Data Converters	dataconverter.ti.com
DSP	dsp.ti.com
Clocks and Timers	www.ti.com/clocks
Interface	interface.ti.com
Logic	logic.ti.com
Power Mgmt	power.ti.com
Microcontrollers	microcontroller.ti.com
RFID	www.ti-rfid.com
RF/IF and ZigBee® Solutions	www.ti.com/lprf

Applications

Audio	www.ti.com/audio
Automotive	www.ti.com/automotive
Broadband	www.ti.com/broadband
Digital Control	www.ti.com/digitalcontrol
Medical	www.ti.com/medical
Military	www.ti.com/military
Optical Networking	www.ti.com/opticalnetwork
Security	www.ti.com/security
Telephony	www.ti.com/telephony
Video & Imaging	www.ti.com/video
Wireless	www.ti.com/wireless

Mailing Address: Texas Instruments, Post Office Box 655303, Dallas, Texas 75265
Copyright © 2008, Texas Instruments Incorporated